

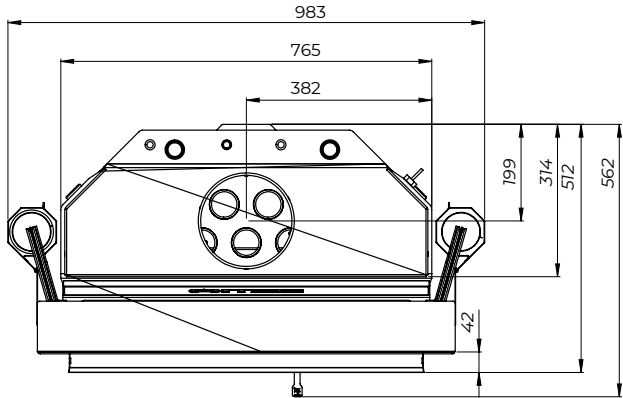

Hestia 1000 Guillotine Glass Fronted

Hestia 1000 Guillotine Glass Fronted

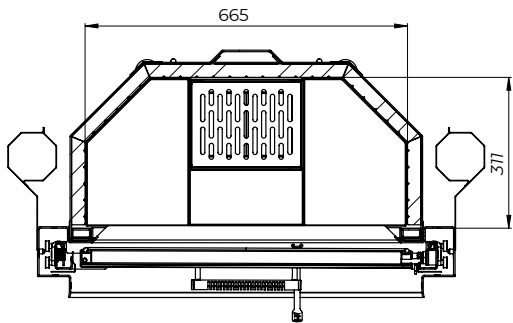
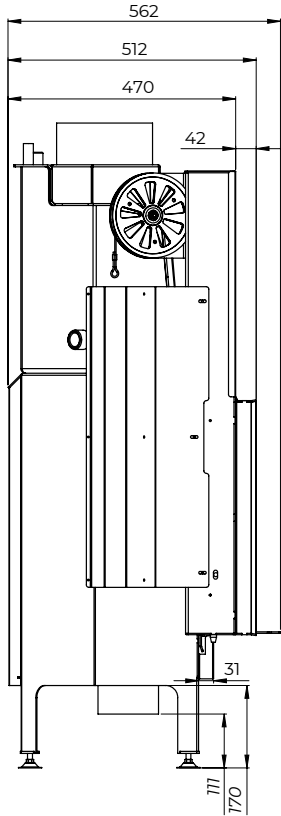
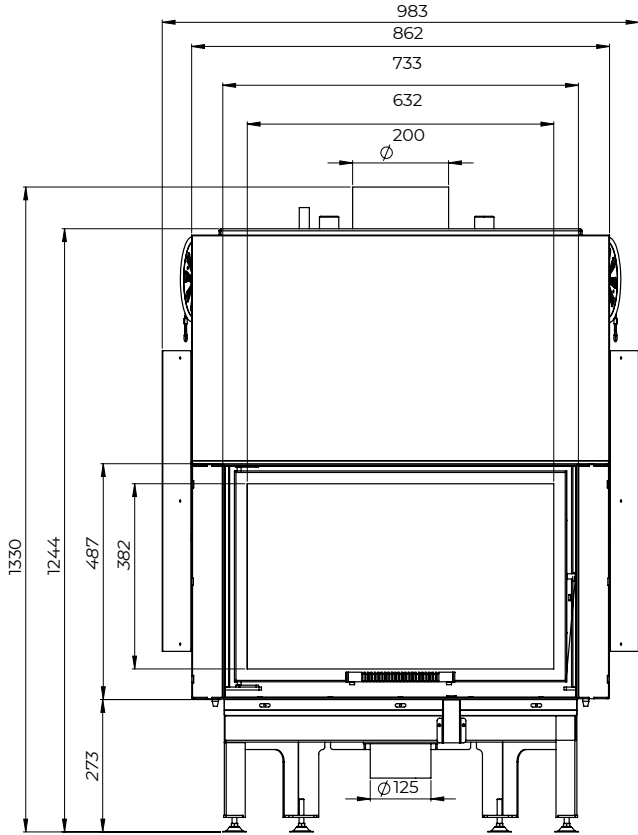

Door Size (mm)	733 x 487
Flue Diameter (mm)	200
Weight (Kg)	246



359-361 Swan St, Richmond VIC 3121 | 148-150 Cochranes Rd, Moorabbin VIC 3189
www.livingfire.com.au | info@livingfire.com.au